



PREMIUM-WERKZEUGE



PREMIUM TOOLS



# RATCHET RING SPANNER

INNOVATIVE RATCHET TECHNOLOGY FROM 5.5 MM TO 41.00 MM!

## GEARplus® COMBINATION RATCHETING SPANNER, STUBBY

- FlankTraction profile
- In accordance to DIN 3113 / ISO 3318
- Jaw 15° offset
- Ratchet head offset at 15°
- With reversing lever
- High quality finish
- Chrome vanadium

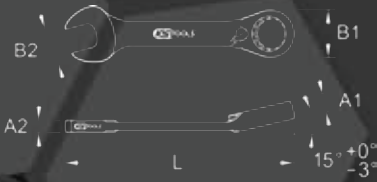
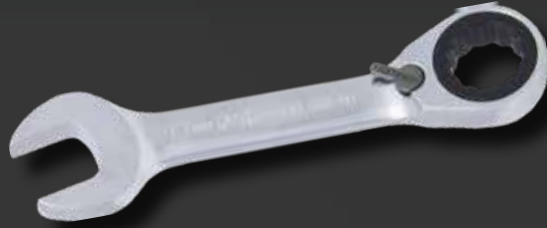

	mm	A1 mm	A2 mm	B1 mm	B2 mm	L mm	
<b>503.4631</b>	8	6,5	4,0	16,6	16,7	90,0	€ 16, <sup>50</sup>
<b>503.4632</b>	9	6,9	4,4	18,4	18,8	93,0	€ 16, <sup>50</sup>
<b>503.4633</b>	10	7,3	4,8	17,0	17,0	90,0	€ 16, <sup>50</sup>
<b>503.4634</b>	11	7,7	5,2	21,8	23,0	103,0	€ 16, <sup>50</sup>
<b>503.4635</b>	12	8,2	5,5	22,7	25,0	106,0	€ 16, <sup>50</sup>
<b>503.4636</b>	13	8,6	5,8	24,7	27,1	108,0	€ 18, <sup>50</sup>
<b>503.4637</b>	14	9,0	6,2	27,0	29,2	115,0	€ 18, <sup>50</sup>
<b>503.4638</b>	15	9,4	6,5	28,3	31,3	119,0	€ 21, <sup>50</sup>
<b>503.4639</b>	16	10,0	6,8	30,0	33,4	123,0	€ 21, <sup>50</sup>
<b>503.4640</b>	17	10,3	7,2	31,8	35,5	127,0	€ 21, <sup>50</sup>
<b>503.4641</b>	18	10,7	7,7	32,6	37,6	131,0	€ 21, <sup>50</sup>
<b>503.4642</b>	19	11,2	8,2	33,8	39,7	139,0	€ 21, <sup>50</sup>

## 503.4652

### GEARplus® COMBINATION RATCHETING SPANNER SET, STUBBY

- FlankTraction profile
- In accordance to DIN 3113 / ISO 3318
- Jaw 15° offset
- Ratchet head offset at 15°
- With reversing lever
- High quality finish
- Chrome vanadium
- In durable plastic storage case



8 - 9 - 10 - 11 - 12 - 13 - 14 - 15 -  
 16 - 17 - 18 - 19 mm

## 503.4653

### GEARplus® COMBINATION RATCHETING SPANNER SET, STUBBY

- FlankTraction profile
- In accordance to DIN 3113 / ISO 3318
- Jaw 15° offset
- Ratchet head offset at 15°
- With reversing lever
- Square drive adaptor to DIN 3120 - ISO 1174 with ball lock
- For bits to DIN 3126 / C 6,3
- High quality finish
- Chrome vanadium
- In durable plastic storage case

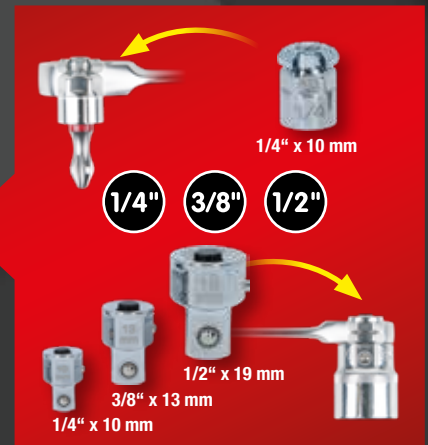

8 - 9 - 10 - 11 - 12 - 13 - 14 - 15 -  
 16 - 17 - 18 - 19 mm  
 1/4" - 3/8" - 1/2"

**218,50** €

\*This is an limited special price offer - only until stocks last.

All prices are ex. VAT. With the release of this leaflet all previous prices became invalid. Sold only in specialist stores. Print mistakes, errors and technical alterations excepted. Prices valid up to 30.09.2023

# COMBINATION WRENCH

## GEARplus® COMBINATION RATCHETING SPANNER

- FlankTraction profile
- In accordance to DIN 3113 / ISO 3318
- Jaw 15° offset
- Straight form
- Exact gearing with 72 teeth
- High quality finish
- Chrome vanadium

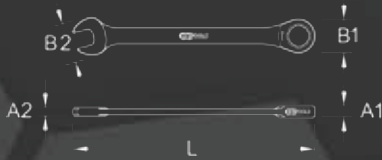

	mm	A1 mm	A2 mm	B1 mm	B2 mm	L mm	
<b>503.42055</b>	5,5	6,3	3,9	14,0	15,0	127,5	€ 10, <sup>90</sup>
<b>503.4206</b>	6	6,3	3,9	14,0	15,0	128,0	€ 10, <sup>90</sup>
<b>503.4207</b>	7	6,5	4,0	16,8	16,7	140,0	€ 10, <sup>90</sup>
<b>503.4208</b>	8	6,5	4,0	16,8	16,7	140,0	€ 10, <sup>90</sup>
<b>503.4209</b>	9	6,9	4,4	18,8	18,7	149,0	€ 10, <sup>90</sup>
<b>503.4210</b>	10	7,3	4,8	20,8	20,8	158,0	€ 10, <sup>90</sup>
<b>503.4211</b>	11	7,7	5,2	21,8	23,0	165,0	€ 10, <sup>90</sup>
<b>503.4212</b>	12	8,2	5,5	22,8	24,6	171,0	€ 11, <sup>90</sup>
<b>503.4213</b>	13	8,6	5,8	24,8	26,8	178,0	€ 11, <sup>90</sup>
<b>503.4214</b>	14	9,0	6,2	27,8	29,0	190,0	€ 16, <sup>50</sup>
<b>503.4215</b>	15	9,4	6,5	28,8	31,0	199,0	€ 16, <sup>50</sup>
<b>503.4216</b>	16	9,9	6,8	30,8	33,0	208,0	€ 18, <sup>50</sup>
<b>503.4217</b>	17	10,3	7,2	31,8	35,5	225,0	€ 18, <sup>50</sup>
<b>503.4218</b>	18	10,7	7,7	32,8	37,5	236,0	€ 18, <sup>50</sup>
<b>503.4219</b>	19	11,2	8,2	33,8	39,4	247,0	€ 18, <sup>50</sup>
<b>503.4221</b>	21	13,0	9,0	40,0	45,8	289,0	€ 27, <sup>90</sup>
<b>503.4222</b>	22	13,0	9,0	40,0	45,8	289,0	€ 29, <sup>90</sup>
<b>503.4224</b>	24	14,5	10,0	46,0	51,8	322,0	€ 34, <sup>50</sup>
<b>503.4227</b>	27	15,5	10,5	52,0	56,4	358,0	€ 52, <sup>50</sup>
<b>503.4228</b>	30	17,0	11,4	58,0	62,7	401,0	€ 57, <sup>90</sup>
<b>503.4229</b>	32	17,5	12,5	62,0	66,4	424,0	€ 66, <sup>50</sup>
<b>503.4230</b>	34	17,5	13,0	62,0	70,0	459,0	€ 72, <sup>90</sup>
<b>503.4252</b>	36	18,0	13,4	66,0	78,0	489,0	€ 94, <sup>50</sup>
<b>503.4253</b>	38	18,0	13,4	66,0	78,0	489,0	€ 100, <sup>50</sup>
<b>503.4248</b>	41	19,5	16,5	71,0	86,0	565,0	€ 170, <sup>50</sup>

		A1 mm	A2 mm	B1 mm	B2 mm	L mm	
<b>503.4102</b>	5/16"	6,5	4,0	16,8	16,7	140,0	€ 10, <sup>90</sup>
<b>503.4103</b>	3/8"	7,3	4,8	20,8	20,8	158,0	€ 10, <sup>90</sup>
<b>503.4104</b>	7/16"	7,7	5,2	21,8	23,0	165,0	€ 11, <sup>90</sup>
<b>503.4105</b>	1/2"	8,6	5,8	24,8	26,8	178,0	€ 11, <sup>90</sup>
<b>503.4106</b>	9/16"	9,0	6,2	27,8	29,0	190,0	€ 16, <sup>50</sup>
<b>503.4107</b>	5/8"	9,9	6,8	30,8	33,0	208,0	€ 18, <sup>50</sup>
<b>503.4108</b>	11/16"	10,3	7,2	31,8	35,5	225,0	€ 18, <sup>50</sup>
<b>503.4109</b>	3/4"	11,2	8,2	33,8	39,4	247,0	€ 18, <sup>50</sup>



\*This is an limited special price offer - only until stocks last.

All prices are ex. VAT. With the release of this leaflet all previous prices became invalid. Sold only in specialist stores. Print mistakes, errors and technical alterations excepted. Prices valid up to 30.09.2023



**503.4204**

**GEARplus® COMBINATION RATCHETING SPANNER SET**

- FlankTraction profile
- In accordance to DIN 3113 / ISO 3318
- Jaw 15° offset
- Straight form
- Exact gearing with 72 teeth
- High quality finish
- Chrome vanadium

**4**  
pcs



10 - 13 - 17 - 19 mm

**57,90** €

**503.4270**

**GEARplus® COMBINATION RATCHETING SPANNER SET**

- FlankTraction profile
- In accordance to DIN 3113 / ISO 3318
- Jaw 15° offset
- Straight form
- Exact gearing with 72 teeth
- Mirror polished
- Chrome vanadium

**4**  
pcs



24 - 27 - 30 - 32 mm

**250,50** €

**503.4255**

**GEARplus® RATCHET COMBINATION SPANNER SET**

- FlankTraction profile
- In accordance to DIN 3113 / ISO 3318
- Jaw 15° offset
- Straight form
- Exact gearing with 72 teeth
- High quality finish
- Chrome vanadium

**5**  
pcs



8 - 10 - 13 - 17 - 19 mm

**72,90** €

**503.4250**

**GEARplus® COMBINATION RATCHETING SPANNER SET**

- FlankTraction profile
- In accordance to DIN 3113 / ISO 3318
- Jaw 15° offset
- Straight form
- Exact gearing with 72 teeth
- High quality finish
- Chrome vanadium

**10**  
pcs



8 - 10 - 11 - 12 - 13 - 14 -  
16 - 17 - 18 - 19 mm

**133,90** €

**503.4202**

**GEARplus® COMBINATION RATCHETING SPANNER SET**

- FlankTraction profile
- In accordance to DIN 3113 / ISO 3318
- Jaw 15° offset
- Straight form
- Exact gearing with 72 teeth
- High quality finish
- Chrome vanadium

**5**  
pcs



**Inches**



5/16" - 3/8" - 1/2" - 11/16" - 3/4"

**72,90** €



# COMBINATION WRENCH

**503.4259**

## GEARplus® COMBINATION RATCHETING SPANNER SET

- FlankTraction profile
- In accordance to DIN 3113 / ISO 3318
- Jaw 15° offset
- Straight form
- Exact gearing with 72 teeth
- High quality finish
- Chrome vanadium
- In durable plastic storage case

**6**  
pcs



8 - 10 - 12 - 13 - 17 - 19 mm

**88,90** €

**503.4265**

## GEARplus® COMBINATION RATCHETING SPANNER SET

- FlankTraction profile
- In accordance to DIN 3113 / ISO 3318
- Jaw 15° offset
- Straight form
- Exact gearing with 72 teeth
- High quality finish
- Chrome vanadium
- In durable plastic storage case

**12**  
pcs



8 - 9 - 10 - 11 - 12 - 13 - 14 -  
15 - 16 - 17 - 18 - 19 mm

**170,50** €

**503.4260**

## GEARplus® COMBINATION RATCHETING SPANNER SET

- FlankTraction profile
- In accordance to DIN 3113 / ISO 3318
- Jaw 15° offset
- Straight form
- Exact gearing with 72 teeth
- Square drive adaptor to DIN 3120 - ISO 1174 with ball lock
- For bits to DIN 3126 / C 6,3
- High quality finish
- Chrome vanadium
- In durable plastic storage case

**10**  
pcs



8 - 10 - 12 - 13 - 17 - 19 mm  
1/4" - 3/8" - 1/2"

**106,90** €

**503.4266**

## GEARplus® COMBINATION RATCHETING SPANNER SET

- FlankTraction profile
- In accordance to DIN 3113 / ISO 3318
- Jaw 15° offset
- Straight form
- Exact gearing with 72 teeth
- Square drive adaptor to DIN 3120 / ISO 1174 with ball lock
- For bits to DIN 3126 / C 6,3
- High quality finish
- Chrome vanadium
- In durable plastic storage case

**16**  
pcs



8 - 9 - 10 - 11 - 12 - 13 - 14 -  
15 - 16 - 17 - 18 - 19 mm  
1/4" - 3/8" - 1/2"

**188,50** €



\*This is an limited special price offer - only until stocks last.

All prices are ex. VAT. With the release of this leaflet all previous prices became invalid. Sold only in specialist stores. Print mistakes, errors and technical alterations excepted. Prices valid up to 30.09.2023

## GEARplus® REVERSING COMBINATION RATCHETING SPANNER

- FlankTraction profile
- In accordance to DIN 3113 / ISO 3318
- Jaw 15° offset
- Ratchet head offset at 15°
- Exact gearing with 72 teeth
- With reversing lever
- High quality finish
- Chrome vanadium

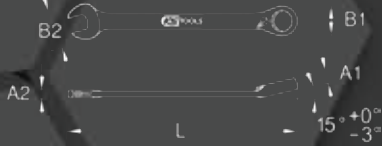

	mm	A1 mm	A2 mm	B1 mm	B2 mm	L mm	
503.4606	6	6,3	3,9	14,0	15,0	127,5	€ 16, <sup>50</sup>
503.4607	7	6,5	4,6	16,4	16,2	140,0	€ 16, <sup>50</sup>
503.4608	8	6,5	4,6	16,4	16,2	140,0	€ 16, <sup>50</sup>
503.4609	9	6,9	4,9	18,3	18,2	150,0	€ 16, <sup>50</sup>
503.4610	10	7,3	5,3	20,0	20,5	159,0	€ 18, <sup>50</sup>
503.4611	11	7,7	5,6	21,4	22,6	166,0	€ 18, <sup>50</sup>
503.4612	12	8,2	6,0	22,6	24,6	172,0	€ 18, <sup>50</sup>
503.4613	13	8,6	6,4	24,5	26,7	178,0	€ 18, <sup>50</sup>
503.4614	14	9,0	6,8	27,0	28,8	191,0	€ 21, <sup>50</sup>
503.4615	15	9,4	7,0	28,2	30,8	200,0	€ 21, <sup>50</sup>
503.4616	16	9,9	7,2	30,3	33,2	208,0	€ 21, <sup>50</sup>
503.4617	17	10,3	7,7	31,6	35,1	225,0	€ 21, <sup>50</sup>
503.4618	18	10,7	8,2	32,3	37,2	236,0	€ 24, <sup>90</sup>
503.4619	19	11,2	8,8	33,7	39,3	248,0	€ 24, <sup>90</sup>
503.4621	21	13,0	9,0	40,1	46,2	290,0	€ 34, <sup>50</sup>
503.4622	22	13,0	9,0	40,1	46,2	290,0	€ 34, <sup>50</sup>
503.4624	24	14,5	10,0	46,5	51,5	323,0	€ 39, <sup>50</sup>
503.4627	27	15,5	10,5	52,5	56,5	357,0	€ 66, <sup>50</sup>
503.4628	30	17,0	11,4	58,5	62,7	400,0	€ 79, <sup>50</sup>
503.4629	32	17,5	12,5	62,5	66,4	423,0	€ 84, <sup>50</sup>
503.4630	34	17,5	13,0	62,5	70,6	460,0	€ 90, <sup>90</sup>
503.4643	36	18,0	13,4	65,8	79,0	488,0	€ 118, <sup>90</sup>
503.4644	38	18,0	13,4	65,8	79,0	488,0	€ 127, <sup>50</sup>
503.4648	41	19,5	16,5	71,0	86,0	565,0	€ 175, <sup>50</sup>



		A1 mm	A2 mm	B1 mm	B2 mm	L mm	
503.4681	5/16"	6,5	4,0	16,6	16,7	145,0	€ 16, <sup>50</sup>
503.4683	3/8"	7,3	4,8	20,0	20,8	159,0	€ 16, <sup>50</sup>
503.4684	7/16"	7,7	5,2	21,8	23,0	165,0	€ 18, <sup>50</sup>
503.4685	1/2"	8,6	5,8	24,7	27,1	178,0	€ 18, <sup>50</sup>
503.4686	9/16"	9,0	6,5	27,0	29,2	190,0	€ 21, <sup>50</sup>
503.4687	5/8"	9,9	6,8	30,0	33,4	208,0	€ 21, <sup>50</sup>
503.4688	11/16"	10,3	7,2	31,8	35,5	225,0	€ 21, <sup>50</sup>
503.4689	3/4"	11,2	8,2	33,8	39,7	248,0	€ 24, <sup>90</sup>

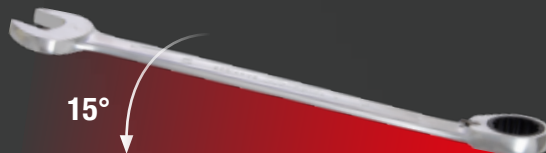

# COMBINATION WRENCH

**503.4604**

## GEARplus® REVERSING COMBINATION RATCHETING SPANNER SET

- FlankTraction profile
- In accordance to DIN 3113 / ISO 3318
- Jaw 15° offset
- Ratchet head offset at 15°
- Exact gearing with 72 teeth
- With reversing lever
- High quality finish
- Chrome vanadium

**4**  
pcs



10 - 13 - 17 - 19 mm

**82,50** €

**503.4605**

## GEARplus® REVERSING COMBINATION RATCHETING SPANNER SET

- FlankTraction profile
- In accordance to DIN 3113 / ISO 3318
- Jaw 15° offset
- Ratchet head offset at 15°
- Exact gearing with 72 teeth
- With reversing lever
- High quality finish
- Chrome vanadium

**5**  
pcs



8 - 10 - 13 - 17 - 19 mm

**90,90** €

**503.4602**

## GEARplus® REVERSING COMBINATION RATCHETING SPANNER SET

- FlankTraction profile
- In accordance to DIN 3113 / ISO 3318
- Jaw 15° offset
- Ratchet head offset at 15°
- Exact gearing with 72 teeth
- With reversing lever
- High quality finish
- Chrome vanadium

**5**  
pcs



**Inches**

5/16" - 3/8" - 1/2" - 11/16" - 3/4"

**90,90** €

**503.4650**

## GEARplus® REVERSING COMBINATION RATCHETING SPANNER SET

- FlankTraction profile
- In accordance to DIN 3113 / ISO 3318
- Jaw 15° offset
- Ratchet head offset at 15°
- Exact gearing with 72 teeth
- With reversing lever
- Square drive adaptor to DIN 3120 - ISO 1174 with ball lock
- For bits to DIN 3126 / C 6,3
- High quality finish
- Chrome vanadium
- In durable plastic storage case

**9**  
pcs



8 - 10 - 12 - 13 - 17 - 19 mm  
1/4" - 3/8" - 1/2"



**118,90** €

\*This is an limited special price offer - only until stocks last.  
All prices are ex. VAT. With the release of this leaflet all previous prices became invalid. Sold only in specialist stores. Print mistakes, errors and technical alterations excepted. Prices valid up to 30.09.2023



**503.4646**

**GEARplus® REVERSING COMBINATION RATCHETING SPANNER SET**

- FlankTraction profile
- In accordance to DIN 3113 / ISO 3318
- Jaw 15° offset
- Ratchet head offset at 15°
- Exact gearing with 72 teeth
- With reversing lever
- High quality finish
- Chrome vanadium
- In durable plastic storage case

**6**  
pcs



15°  
R L  
8 - 10 - 12 - 13 - 17 - 19 mm

**118,90** €

**503.4665**

**GEARplus® REVERSING COMBINATION RATCHETING SPANNER SET**

- FlankTraction profile
- In accordance to DIN 3113 / ISO 3318
- Jaw 15° offset
- Ratchet head offset at 15°
- Exact gearing with 72 teeth
- With reversing lever
- High quality finish
- Chrome vanadium
- In durable plastic storage case

**12**  
pcs



15°  
R L  
8 - 9 - 10 - 11 - 12 - 13 - 14 - 15 -  
16 - 17 - 18 - 19 mm

**218,50** €

**503.4647**

**GEARplus® REVERSING COMBINATION RATCHETING SPANNER SET**

- FlankTraction profile
- In accordance to DIN 3113 / ISO 3318
- Jaw 15° offset
- Ratchet head offset at 15°
- Exact gearing with 72 teeth
- With reversing lever
- Square drive adaptor to DIN 3120 / ISO 1174 with ball lock
- For bits to DIN 3126 / C 6,3
- High quality finish
- Chrome vanadium
- In durable plastic storage case

**10**  
pcs



15°  
R L  
8 - 10 - 12 - 13 - 17 - 19 mm  
1/4" - 3/8" - 1/2"

**157,50** €

**503.4666**

**GEARplus® REVERSING COMBINATION RATCHETING SPANNER SET**

- FlankTraction profile
- In accordance to DIN 3113 / ISO 3318
- Jaw 15° offset
- Ratchet head offset at 15°
- Exact gearing with 72 teeth
- With reversing lever
- Square drive adaptor to DIN 3120 / ISO 1174 with ball lock
- For bits to DIN 3126 / C 6,3
- High quality finish
- Chrome vanadium
- In durable plastic storage case

**16**  
pcs



15°  
R L  
8 - 9 - 10 - 11 - 12 - 13 - 14 - 15 -  
16 - 17 - 18 - 19 mm  
1/4" - 3/8" - 1/2"

**241,90** €



8 - 10 - 12 - 13 - 17 - 19 mm  
1/4" - 3/8" - 1/2"

8 - 9 - 10 - 11 - 12 - 13 - 14 - 15 -  
16 - 17 - 18 - 19 mm  
1/4" - 3/8" - 1/2"

\*This is an limited special price offer - only until stocks last.

All prices are ex. VAT. With the release of this leaflet all previous prices became invalid. Sold only in specialist stores. Print mistakes, errors and technical alterations excepted. Prices valid up to 30.09.2023

# COMBINATION WRENCH

## GEARplus® REVERSING COMBINATION RATCHETING SPANNER

- FlankTraction profile
- In accordance to DIN 3113 / ISO 3318
- Jaw 15° offset
- Ratchet head offset at 15°
- With reversing lever
- Ring stop function
- High quality finish
- Chrome vanadium



	mm	A1 mm	A2 mm	B1 mm	B2 mm	L mm	
<b>503.4908</b>	8	6,5	4,6	16,6	16,7	140,0	€ 16, <sup>50</sup>
<b>503.4909</b>	9	6,9	4,9	18,4	18,8	150,0	€ 16, <sup>50</sup>
<b>503.4910</b>	10	7,3	5,3	20,0	20,8	159,0	€ 18, <sup>50</sup>
<b>503.4911</b>	11	7,7	5,6	21,8	23,0	165,0	€ 18, <sup>50</sup>
<b>503.4912</b>	12	8,2	6,0	22,7	25,0	172,0	€ 18, <sup>50</sup>
<b>503.4913</b>	13	8,6	6,4	24,7	27,1	178,0	€ 18, <sup>50</sup>
<b>503.4914</b>	14	9,0	6,8	27,0	29,2	191,0	€ 21, <sup>50</sup>
<b>503.4915</b>	15	9,4	7,0	28,3	31,1	200,0	€ 21, <sup>50</sup>
<b>503.4916</b>	16	9,9	7,2	30,0	33,4	208,0	€ 21, <sup>50</sup>
<b>503.4917</b>	17	10,3	7,7	31,8	35,5	226,0	€ 21, <sup>50</sup>
<b>503.4918</b>	18	10,7	8,2	32,6	37,6	237,0	€ 24, <sup>90</sup>
<b>503.4919</b>	19	11,2	8,8	33,8	39,7	248,0	€ 24, <sup>90</sup>

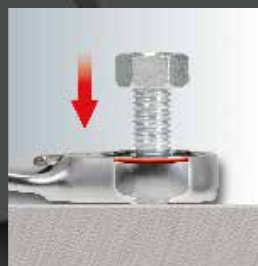

## 503.4955

### GEARplus® REVERSING COMBINATION RATCHETING SPANNER SET

- FlankTraction profile
- In accordance to DIN 3113 / ISO 3318
- Jaw 15° offset
- Ratchet head offset at 15°
- With reversing lever
- High quality finish
- Chrome vanadium
- In durable plastic storage case



5  
pcs

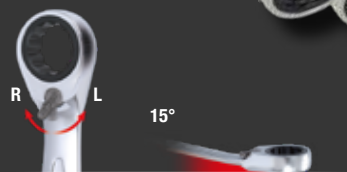
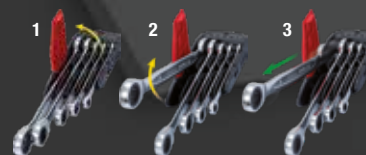

8 - 9 - 13 - 17 - 19 mm

**100,<sup>50</sup>** €

# COMBINATION WRENCH

## GEARplus® SOCKET ADAPTER WITH GO THROUGH

- FlankTraction profile
- With go through function
- Suitable for ring stop spanners
- High quality finish
- Chrome vanadium

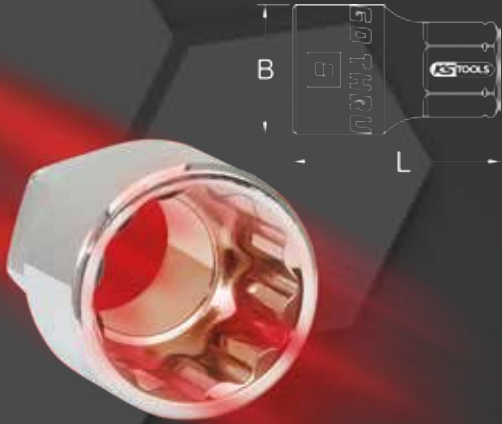

	mm	B mm	L mm	
<b>503.4978</b>	8	12,0	19,8	€ 3, <sup>50</sup>
<b>503.4979</b>	9	12,0	21,2	€ 3, <sup>50</sup>
<b>503.4980</b>	10	15,0	22,6	€ 3, <sup>50</sup>
<b>503.4981</b>	11	16,2	22,9	€ 3, <sup>50</sup>
<b>503.4982</b>	12	17,4	24,5	€ 3, <sup>50</sup>
<b>503.4983</b>	13	18,7	25,8	€ 3, <sup>50</sup>
<b>503.4984</b>	14	19,9	26,1	€ 4, <sup>50</sup>
<b>503.4985</b>	15	20,8	28,0	€ 4, <sup>50</sup>
<b>503.4986</b>	16	22,6	29,5	€ 4, <sup>50</sup>
<b>503.4987</b>	17	23,7	30,6	€ 4, <sup>50</sup>
<b>503.4988</b>	18	24,5	32,0	€ 4, <sup>50</sup>
<b>503.4989</b>	19	26,1	33,5	€ 4, <sup>50</sup>

## 503.4960

### GEARplus® REVERSING COMBINATION RATCHETING SPANNER SET

- FlankTraction profile
- In accordance to DIN 3113 / ISO 3318
- Jaw 15° offset
- Ratchet head offset at 15°
- With reversing lever
- Versatile sockets with go through function
- Square drive adaptor to DIN 3120 / ISO 1174 with ball lock
- For bits to DIN 3126 / C 6,3
- High quality finish
- Chrome vanadium
- In durable plastic storage case



**30**  
pcs

1/4" 5/16" 10 mm

1/4" 3/8" 1/2"

10 x 13 mm  
 5/16" x 10 mm  
 1/4" x 10 mm

1/2" x 19 mm  
 3/8" x 13 mm  
 1/4" x 10 mm

8 - 9 - 10 - 11 - 12 - 13 - 14 - 15 - 16 - 17 - 18 - 19 mm  
 1/4" - 3/8" - 1/2"  
 1/4" - 5/16" - 10 mm

**168,<sup>90</sup>** €



# COMBINATION WRENCH

## DUO GEARplus® COMBINATION SPANNER SET WITH RATCHET MECHANISM IN RING AND OPEN JAW

- Open end side with innovative ratchet mechanism
- FlankTraction profile
- In accordance to DIN 3113 / ISO 3318
- Jaw 15° offset
- Straight form
- Exact gearing with 72 teeth
- High quality finish
- Chrome vanadium



**DUO GEARplus®**



	Ø mm	A1 mm	A2 mm	B1 mm	B2 mm	L mm	Nm	Ø Nm	
<b>503.5208</b>	8	6,5	4,1	16,4	16,2	140,0	15,0	36,0	€ 16, <sup>50</sup>
<b>503.5209</b>	9	6,9	4,3	18,3	18,3	150,0	21,1	48,0	€ 18, <sup>50</sup>
<b>503.5210</b>	10	7,3	4,8	20,0	20,0	159,0	31,1	85,2	€ 18, <sup>50</sup>
<b>503.5211</b>	11	7,7	5,1	21,4	21,4	166,0	46,1	96,0	€ 18, <sup>50</sup>
<b>503.5212</b>	12	8,2	5,3	22,6	22,6	172,0	49,1	109,2	€ 18, <sup>50</sup>
<b>503.5213</b>	13	8,6	5,9	24,5	24,5	178,0	62,1	138,0	€ 21, <sup>50</sup>
<b>503.5214</b>	14	9,0	6,3	27,0	27,0	191,0	86,0	189,6	€ 21, <sup>50</sup>
<b>503.5215</b>	15	9,4	6,6	28,2	28,2	200,0	104,1	240,0	€ 21, <sup>50</sup>
<b>503.5216</b>	16	9,9	6,9	30,3	30,3	208,0	124,1	297,6	€ 21, <sup>50</sup>
<b>503.5217</b>	17	10,3	7,3	31,6	31,6	225,0	139,1	320,4	€ 24, <sup>90</sup>
<b>503.5218</b>	18	10,7	7,8	32,3	32,3	236,0	155,1	364,8	€ 24, <sup>90</sup>
<b>503.5219</b>	19	11,2	8,3	33,7	33,7	248,0	186,1	387,6	€ 24, <sup>90</sup>
<b>503.5221</b>	21	13,0	8,8	40,1	46,2	290,0	248,1	446,4	€ 39, <sup>50</sup>
<b>503.5224</b>	24	14,5	9,8	46,5	51,5	323,0	341,2	610,8	€ 46, <sup>50</sup>
<b>503.5227</b>	27	15,5	10,4	52,9	56,1	352,0	432,0	805,2	€ 66, <sup>50</sup>
<b>503.5228</b>	30	17,1	11,2	57,6	62,5	396,0	570,0	954,0	€ 79, <sup>50</sup>
<b>503.5229</b>	32	17,6	12,1	61,9	66,2	418,0	650,0	1086,0	€ 94, <sup>50</sup>



## 503.5205

### DUO GEARplus® COMBINATION SPANNER SET WITH RATCHET MECHANISM IN RING AND OPEN JAW

- Open end side with innovative ratchet mechanism
- FlankTraction profile
- In accordance to DIN 3113 / ISO 3318
- Jaw 15° offset
- Straight form
- Exact gearing with 72 teeth
- High quality finish
- Chrome vanadium
- In durable plastic storage case



**5**  
pcs

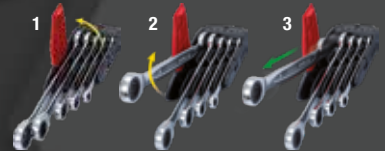
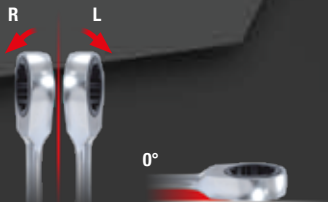

8 - 10 - 13 - 17 - 19 mm

**102,<sup>90</sup>** €



\*This is an limited special price offer - only until stocks last.

All prices are ex. VAT. With the release of this leaflet all previous prices became invalid. Sold only in specialist stores. Print mistakes, errors and technical alterations excepted. Prices valid up to 30.09.2023

## DUO GEARplus® COMBINATION SPANNER WITH RATCHET MECHANISM IN RING AND OPEN JAW, REVERSIBLE

- Open end side with innovative ratchet mechanism
- FlankTraction profile
- In accordance to DIN 3113 / ISO 3318
- Jaw 15° offset
- Ring head 15° offset
- With reversing lever
- Exact gearing with 72 teeth
- High quality finish
- Chrome vanadium

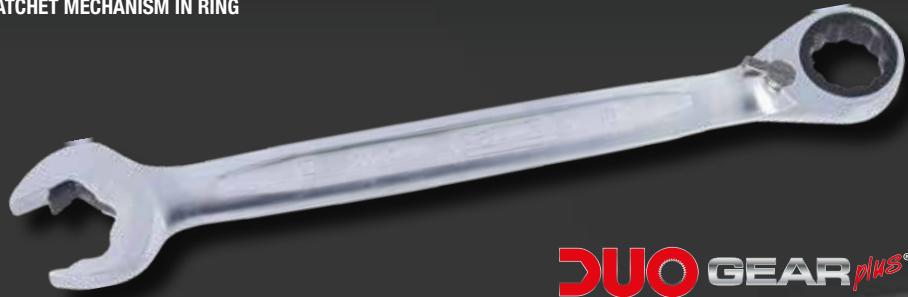

**DUO GEARplus®**

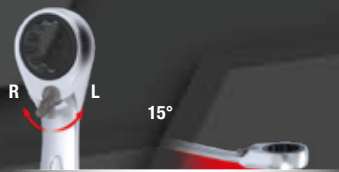
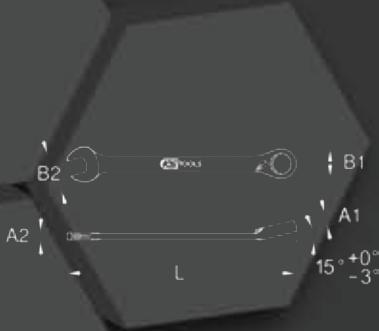

	mm	A1 mm	A2 mm	B1 mm	B2 mm	L mm	Nm	Ø Nm	
<b>503.5908</b>	8	6,5	4,1	16,4	16,2	140,0	15,0	36,0	€ 21, <sup>50</sup>
<b>503.5909</b>	9	6,9	4,3	18,3	18,2	150,0	21,1	48,0	€ 21, <sup>50</sup>
<b>503.5910</b>	10	7,3	4,8	20,0	20,5	159,0	31,1	85,2	€ 21, <sup>50</sup>
<b>503.5911</b>	11	7,7	5,1	21,4	22,6	166,0	46,1	96,0	€ 21, <sup>50</sup>
<b>503.5912</b>	12	8,2	5,3	22,6	24,6	172,0	49,1	109,2	€ 21, <sup>50</sup>
<b>503.5913</b>	13	8,6	5,9	24,5	26,7	178,0	62,1	138,0	€ 21, <sup>50</sup>
<b>503.5914</b>	14	9,0	6,3	27,0	28,8	191,0	86,0	189,6	€ 24, <sup>90</sup>
<b>503.5915</b>	15	9,4	6,6	28,2	30,8	200,0	104,1	240,0	€ 18, <sup>50</sup>
<b>503.5916</b>	16	9,9	6,9	30,3	33,2	208,0	124,1	297,6	€ 27, <sup>90</sup>
<b>503.5917</b>	17	10,3	7,3	31,6	35,1	225,0	139,1	320,4	€ 27, <sup>90</sup>
<b>503.5918</b>	18	10,7	7,8	32,3	37,2	236,0	155,1	364,8	€ 27, <sup>90</sup>
<b>503.5919</b>	19	11,2	8,3	33,7	39,3	248,0	186,1	387,6	€ 27, <sup>90</sup>
<b>503.5921</b>	21	13,0	8,8	40,1	46,2	290,0	248,1	446,4	€ 42, <sup>90</sup>
<b>503.5922</b>	22	13,0	8,8	40,0	46,2	290,0	279,1	489,6	€ 42, <sup>90</sup>
<b>503.5924</b>	24	14,5	9,8	46,5	51,5	323,0	341,2	610,8	€ 52, <sup>50</sup>
<b>503.5927</b>	27	15,5	10,4	52,9	56,1	352,0	432,0	805,2	€ 79, <sup>50</sup>
<b>503.5928</b>	30	17,1	11,2	57,6	62,5	396,0	570,0	954,0	€ 90, <sup>90</sup>
<b>503.5929</b>	32	17,6	12,1	61,9	66,2	418,0	650,0	1086,0	€ 106, <sup>90</sup>

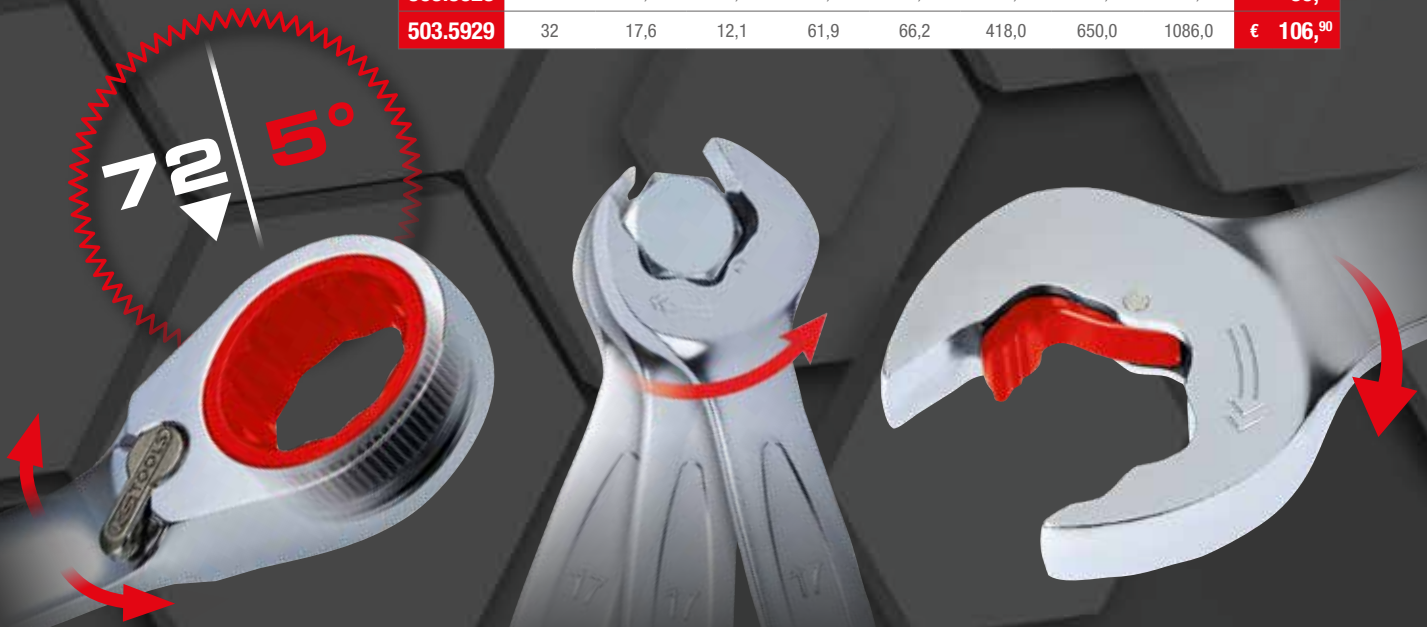

**DUO GEARplus®**

# COMBINATION WRENCH

**503.5905**

## DUO GEARplus® COMBINATION SPANNER SET WITH RATCHET MECHANISM IN RING AND OPEN JAW, REVERSIBLE

- Open end side with innovative ratchet mechanism
- FlankTraction profile
- In accordance to DIN 3113 / ISO 3318
- Jaw 15° offset
- Ring head 15° offset
- With reversing lever
- Exact gearing with 72 teeth
- High quality finish
- Chrome vanadium
- In durable plastic storage case



**5**  
pcs

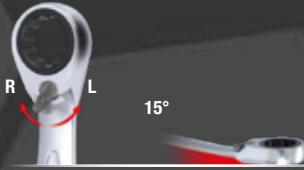

8 - 10 - 13 - 17 - 19 mm

**118,90** €

**503.5950**

## DUO GEARPLUS® COMBINATION RATCHET WRENCH WITH RATCHET FUNCTION, REVERSIBLE

- Open end side with innovative ratchet mechanism
- FlankTraction profile
- In accordance to DIN 3113 / ISO 3318
- Jaw 15° offset
- Ring head 15° offset
- With reversing lever
- Exact gearing with 72 teeth
- High quality finish
- Chrome vanadium



**10**  
pcs

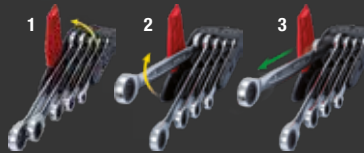

8 - 10 - 11 - 12 - 13 - 14 - 16 - 17 - 18 - 19 mm

**266,50** €





## GEARplus® FLEXIBLE LOCKING COMBINATION RATCHETING SPANNER

- FlankTraction profile
- In accordance to DIN 3113 / ISO 3318
- Jaw 15° offset
- With flexible locking head
- Exact gearing with 72 teeth
- 180° revolving head
- High quality finish
- Chrome vanadium



	mm	A1 mm	A2 mm	B1 mm	B2 mm	L mm	
<b>503.4808</b>	8	6,5	4,3	16,7	16,2	127,0	€ 21, <sup>50</sup>
<b>503.4809</b>	9	6,9	4,6	18,6	18,2	131,5	€ 21, <sup>50</sup>
<b>503.4810</b>	10	7,3	5,0	20,0	20,3	136,0	€ 21, <sup>50</sup>
<b>503.4811</b>	11	7,7	5,4	21,8	22,5	141,0	€ 21, <sup>50</sup>
<b>503.4812</b>	12	8,2	5,8	23,0	24,3	147,5	€ 21, <sup>50</sup>
<b>503.4813</b>	13	8,6	6,1	25,2	26,8	154,0	€ 21, <sup>50</sup>
<b>503.4814</b>	14	9,0	6,4	26,8	28,7	160,0	€ 24, <sup>90</sup>
<b>503.4815</b>	15	9,4	6,9	28,3	30,5	169,0	€ 24, <sup>90</sup>
<b>503.4816</b>	16	9,9	7,2	29,8	32,9	179,0	€ 27, <sup>90</sup>
<b>503.4817</b>	17	10,3	7,6	31,8	34,5	190,0	€ 27, <sup>90</sup>
<b>503.4818</b>	18	10,7	8,0	32,8	37,0	203,0	€ 29, <sup>90</sup>
<b>503.4819</b>	19	11,2	8,6	33,9	39,2	215,0	€ 29, <sup>90</sup>

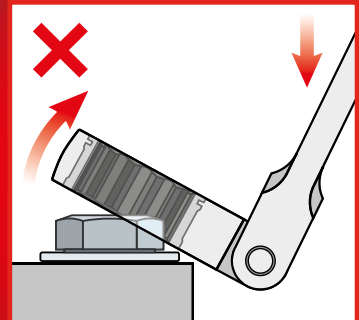
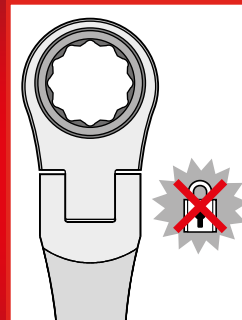
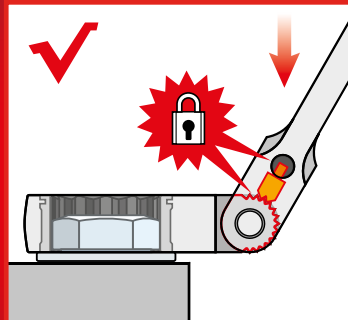
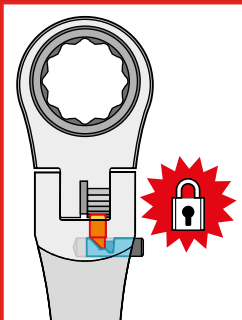
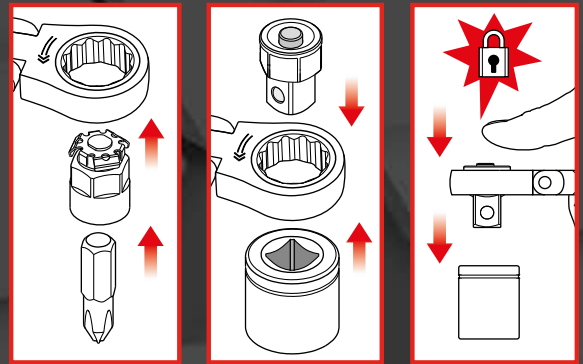

# FLEXIBLE COMBINATION SPANNERS

**503.4859**

## GEARplus® FLEXIBLE LOCKING COMBINATION RATCHETING SPANNER SET

- FlankTraction profile
- In accordance to DIN 3113 / ISO 3318
- Jaw 15° offset
- With flexible locking head
- Exact gearing with 72 teeth
- 180° revolving head
- High quality finish
- Chrome vanadium
- In durable plastic storage case



8 - 10 - 12 - 13 - 17 - 19 mm

**145,50** €

**6**  
pcs

**503.4865**

## GEARplus® FLEXIBLE LOCKING COMBINATION RATCHETING SPANNER SET

- FlankTraction profile
- In accordance to DIN 3113 / ISO 3318
- Jaw 15° offset
- With flexible locking head
- Exact gearing with 72 teeth
- 180° revolving head
- High quality finish
- Chrome vanadium
- In durable plastic storage case



8 - 9 - 10 - 11 - 12 - 13 - 14 -  
15 - 16 - 17 - 18 - 19 mm

**278,50** €

**12**  
pcs

**503.4867**

## GEARplus® FLEXIBLE LOCKING COMBINATION RATCHETING SPANNER SET

- FlankTraction profile
- In accordance to DIN 3113 / ISO 3318
- Jaw 15° offset
- With flexible locking head
- Exact gearing with 72 teeth
- 180° revolving head
- Square drive adaptor to DIN 3120 / ISO 1174 with ball lock
- For bits to DIN 3126 / C 6.3
- High quality finish
- Chrome vanadium
- In durable plastic storage case



8 - 10 - 12 - 13 - 17 - 19 mm  
1/4" - 5/16" - 10 mm  
1/4" - 3/8" - 1/2"

**170,50** €

**12**  
pcs

**503.4868**

## GEARplus® FLEXIBLE LOCKING COMBINATION RATCHETING SPANNER SET

- FlankTraction profile
- In accordance to DIN 3113 / ISO 3318
- Jaw 15° offset
- With flexible locking head
- Exact gearing with 72 teeth
- 180° revolving head
- Square drive adaptor to DIN 3120 / ISO 1174 with ball lock
- For bits to DIN 3126 / C 6.3
- High quality finish
- Chrome vanadium
- In durable plastic storage case



8 - 9 - 10 - 11 - 12 - 13 - 14 -  
15 - 16 - 17 - 18 - 19 mm  
1/4" - 5/16" - 10 mm  
1/4" - 3/8" - 1/2"

**296,50** €

**18**  
pcs



\*This is an limited special price offer - only until stocks last.

All prices are ex. VAT. With the release of this leaflet all previous prices became invalid. Sold only in specialist stores. Print mistakes, errors and technical alterations excepted. Prices valid up to 30.09.2023

## GEARplus® DOUBLE RATCHET RING SPANNER

- FlankTraction profile
- In accordance to DIN 3110 / ISO 3318
- Straight form
- Exact gearing with 72 teeth
- Mirror polished
- Chrome vanadium

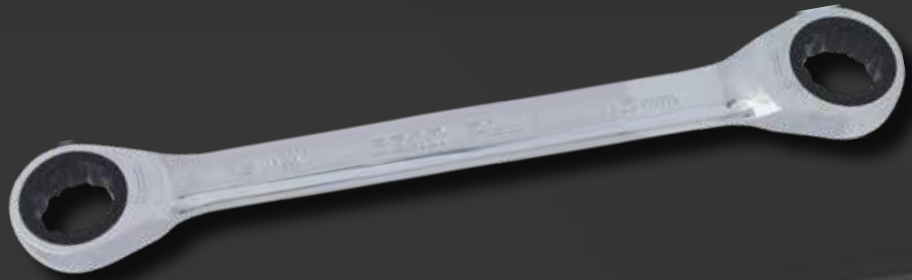

0°



	mm	A1 mm	A2 mm	B1 mm	B2 mm	L mm	
<b>503.4502</b>	8x9	6,5	6,9	16,8	20,2	128,0	€ 18, <sup>50</sup>
<b>503.4511</b>	8x10	7,3	6,5	20,0	17,0	128,0	€ 18, <sup>50</sup>
<b>503.4503</b>	10x11	7,3	7,7	20,2	20,2	150,0	€ 18, <sup>50</sup>
<b>503.4512</b>	10x13	7,3	8,6	20,2	20,2	150,0	€ 18, <sup>50</sup>
<b>503.4504</b>	12x13	8,2	8,6	23,0	23,0	170,0	€ 21, <sup>50</sup>
<b>503.4505</b>	14x15	9,0	9,4	26,5	26,5	190,0	€ 21, <sup>50</sup>
<b>503.4506</b>	16x18	9,9	10,7	29,5	29,5	210,0	€ 24, <sup>90</sup>
<b>503.4507</b>	17x19	10,3	11,2	31,5	31,5	230,0	€ 24, <sup>90</sup>

	mm	A1 mm	A2 mm	B1 mm	B2 mm	L mm	
<b>503.4402</b>	5/16"x3/8"	6,5	7,3	16,8	20,2	128,0	€ 18, <sup>50</sup>
<b>503.4403</b>	7/16"x1/2"	7,7	8,6	23,0	24,8	170,0	€ 18, <sup>50</sup>
<b>503.4404</b>	9/16"x5/8"	9,0	9,9	26,5	29,5	190,0	€ 21, <sup>50</sup>
<b>503.4405</b>	11/16"x3/4"	10,3	11,2	31,5	33,5	230,0	€ 24, <sup>90</sup>



**72**▼  
**5°**



# DOUBLE RING SPANNERS

**503.4552**

## GEARplus® DOUBLE RATCHET RING SPANNER SET

- FlankTraction profile
- In accordance to DIN 3310 / ISO 3318
- Straight form
- Exact gearing with 72 teeth
- Mirror polished
- Chrome vanadium



**2**  
pcs

10x13 - 17x19 mm

**47,50** €

**503.4557**

## GEARplus® DOUBLE RATCHET RING SPANNER SET

- FlankTraction profile
- In accordance to DIN 3310 / ISO 3318
- Straight form
- Exact gearing with 72 teeth
- Mirror polished
- Chrome vanadium
- Supplied in a leather pouch



**6**  
pcs

8x9 - 10x11 - 12x13 - 14x15 - 16x18 - 17x19 mm

**133,90** €

**503.4745**

## 4 IN 1 GEARPLUS® FLEXIBLE REVERSING DOUBLE RATCHET RING SPANNER

- FlankTraction profile
- Straight form
- Exact gearing with 72 teeth
- With flexible head
- Four different sizes on each spanner
- With reversing lever
- High quality finish
- Chrome vanadium



10x13 - 17x19 mm

**46,50** €

**503.4556**

## GEARplus® DOUBLE RATCHET RING SPANNER SET

- FlankTraction profile
- In accordance to DIN 3310 / ISO 3318
- Straight form
- Exact gearing with 72 teeth
- Mirror polished
- Chrome vanadium
- In durable plastic storage case



8x9 - 10x11 - 12x13 - 14x15 - 16x18 - 17x19 mm

**127,50** €

**503.4560**

## GEARplus® DOUBLE RATCHET RING SPANNER SET

- FlankTraction profile
- In accordance to DIN 3310 / ISO 3318
- Straight form
- Exact gearing with 72 teeth
- Square drive adaptor to DIN 3120 / ISO 1174 with ball lock
- For bits to DIN 3126 / C 6.3
- Mirror polished
- Chrome vanadium
- In durable plastic storage case



8x9 - 10x11 - 12x13 - 14x15 - 16x18 - 17x19 mm  
1/4" - 3/8" - 1/2"

**10**  
pcs



**139,50** €

\*This is an limited special price offer - only until stocks last.

All prices are ex. VAT. With the release of this leaflet all previous prices became invalid. Sold only in specialist stores. Print mistakes, errors and technical alterations excepted. Prices valid up to 30.09.2023

## 4 IN 1 GEARplus® REVERSING DOUBLE RATCHET RING SPANNER

- FlankTraction profile
- Straight form
- Exact gearing with 72 teeth
- Four different sizes on each spanner
- With reversing lever
- High quality finish
- Chrome vanadium

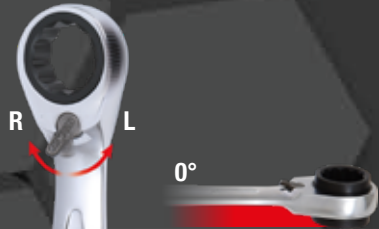

	mm	A1 mm	A2 mm	A3 mm	A4 mm	B1 mm	B2 mm	L mm	
<b>503.4541</b>	8x11-9x10	7,7	7,3	14,6	13,8	21,8	20,0	150,0	€ 21, <sup>50</sup>
<b>503.4656</b>	8x10-12x13	8,6	7,3	16,8	13,8	24,8	16,8	150,0	€ 21, <sup>50</sup>
<b>503.4543</b>	12x15-13x14	9,4	9,0	18,0	17,1	29,5	18,0	190,0	€ 27, <sup>90</sup>
<b>503.4565</b>	10x19-13x17	11,2	9,0	21,9	17,1	33,6	21,9	190,0	€ 19, <sup>90</sup>
<b>503.4546</b>	16x19-17x18	11,2	10,3	21,9	20,2	33,5	21,9	230,0	€ 29, <sup>90</sup>
<b>503.4657</b>	14x17-18x19	11,2	10,3	21,9	19,3	33,5	21,9	230,0	€ 29, <sup>90</sup>
<b>503.4553</b>	21x27-22x24	16,0	13,0	30,0	26,0	52,0	40,0	275,0	€ 72, <sup>90</sup>
<b>503.4554</b>	30x36-32x34	18,0	18,0	36,0	35,0	65,0	62,0	360,0	€ 120, <sup>90</sup>

### 503.4655

#### 4 IN 1 GEARplus® REVERSING DOUBLE RATCHET RING SPANNER

- FlankTraction profile
- Straight form
- Exact gearing with 72 teeth
- Four different sizes on each spanner
- With reversing lever
- High quality finish
- Chrome vanadium



**2**  
pcs

8x10 - 12x13 - 14x17 - 18x19 mm

**57,<sup>90</sup>** €

### 503.4550

#### 4 IN 1 GEARplus® REVERSING DOUBLE RATCHET RING SPANNER

- FlankTraction profile
- Straight form
- Exact gearing with 72 teeth
- Four different sizes on each spanner
- With reversing lever
- High quality finish
- Chrome vanadium



**2**  
pcs

21x27 - 22x24 - 30x36 - 32x34 mm

**200,<sup>50</sup>** €

# DOUBLE RING SPANNERS

**503.4540**

## 4 IN 1 GEARplus® REVERSING DOUBLE RATCHET RING SPANNER SET

- FlankTraction profile
- Straight form
- Exact gearing with 72 teeth
- Four different sizes on each spanner
- With reversing lever
- High quality finish
- Chrome vanadium

**3**  
pcs



8x11 - 9x10 - 12x15 - 13x14 -  
16x19 - 17x18 mm

**79,50** €

**918.3072**

## 11 MM + 1/4" GO THROUGH REVERSING RATCHET

- Especially handy and compact
- Rotating assembly
- Very flat design for hard to access places
- Ratchet head offset at 15°
- Exact gearing with 72 teeth
- With reversing lever
- Matt finish
- Chrome vanadium



1/4" + 11 mm

1/4" 11 mm

**24,90** €

## GEARplus® REVERSING DOUBLE RATCHET RING SPANNER

- FlankTraction profile
- In accordance to DIN 3110 / ISO 3318
- Ratchet head 15° offset
- Exact gearing with 72 teeth
- With reversing lever
- High quality finish
- Chrome vanadium



	mm	A1 mm	A2 mm	B1 mm	B2 mm	L mm	
<b>503.4571</b>	8x9	6,9	6,5	20,2	16,8	128,0	€ 21,50
<b>503.4572</b>	8x10	7,4	6,7	20,2	16,7	128,0	€ 21,50
<b>503.4573</b>	10x11	7,7	7,3	21,8	20,2	150,0	€ 21,50
<b>503.4574</b>	10x13	8,7	7,4	25,4	20,5	150,0	€ 21,50
<b>503.4575</b>	12x13	8,6	8,2	24,8	23,0	170,0	€ 24,90
<b>503.4576</b>	14x15	9,4	9,0	29,5	26,5	190,0	€ 27,90
<b>503.4577</b>	16x18	10,7	9,9	33,5	29,5	210,0	€ 29,90
<b>503.4578</b>	17x19	11,2	10,3	33,5	31,5	230,0	€ 29,90

**503.4580**

## GEARplus® DOUBLE REVERSING RATCHET RING SPANNER

- FlankTraction profile
- In accordance to DIN 3110 / ISO 3318
- Ratchet head 15° offset
- Exact gearing with 72 teeth
- With reversing lever
- High quality finish
- Chrome vanadium
- Supplied in a leather pouch



**6**  
pcs

8x9 - 10x11 - 12x13 - 14x15 -  
16x18 - 17x19 mm

**157,50** €

\*This is an limited special price offer - only until stocks last.

All prices are ex. VAT. With the release of this leaflet all previous prices became invalid. Sold only in specialist stores. Print mistakes, errors and technical alterations excepted. Prices valid up to 30.09.2023



## RATCHET RING SPANNER, REVERSING

- FlankTraction profile
- In accordance to DIN 838 / ISO 1085
- Ring head 75° offset
- Reversible
- Exact gearing with 24 teeth
- Matt finish
- Chrome vanadium

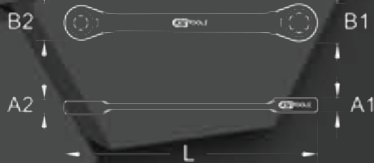

	mm	A1 mm	A2 mm	B1 mm	B2 mm	L mm	
<b>520.1011</b>	10x11	11,5	11,7	23,3	25,1	210,0	€ 39, <sup>50</sup>
<b>520.1214</b>	12x14	12,1	12,4	26,4	30,8	245,0	€ 46, <sup>50</sup>
<b>520.1317</b>	13x17	13,2	13,3	31,5	36,3	265,0	€ 52, <sup>50</sup>
<b>520.1516</b>	15x16	14,6	14,7	33,1	34,9	260,0	€ 52, <sup>50</sup>
<b>520.1922</b>	19x22	16,1	16,2	39,8	43,8	325,0	€ 57, <sup>90</sup>
<b>520.2427</b>	24x27	17,7	17,9	47,4	51,6	390,0	€ 72, <sup>90</sup>
<b>520.3032</b>	30x32	19,7	19,9	55,1	57,1	410,0	€ 84, <sup>50</sup>



## 520.1000

### RATCHET RING SPANNER SET, REVERSING

- FlankTraction profile
- In accordance to DIN 838 / ISO 1085
- Ring head 75° offset
- Reversible
- Exact gearing with 24 teeth
- Matt finish
- Chrome vanadium

**5**  
pcs



10x11 - 12x14 - 13x17 - 15x16 - 19x22 mm

**266,<sup>50</sup>** €

## 520.1100

### RATCHET RING SPANNER SET, REVERSING

- FlankTraction profile
- In accordance to DIN 838 / ISO 1085
- Ring head 75° offset
- Reversible
- Exact gearing with 24 teeth
- Matt finish
- Chrome vanadium

**7**  
pcs



10x11 - 12x14 - 13x17 - 15x16 -  
19x22 - 24x27 - 30x32 mm

**405,<sup>50</sup>** €

# DOUBLE RING SPANNERS

## GEARplus® DOUBLE RING RATCHET SPANNER FOR TORX E PROFILE

- Ideally suited for the assembly and disassembly in tight-fitting areas and changing the transmission
- Torx E
- Straight form
- Exact gearing with 72 teeth
- Mirror polished
- Chrome vanadium

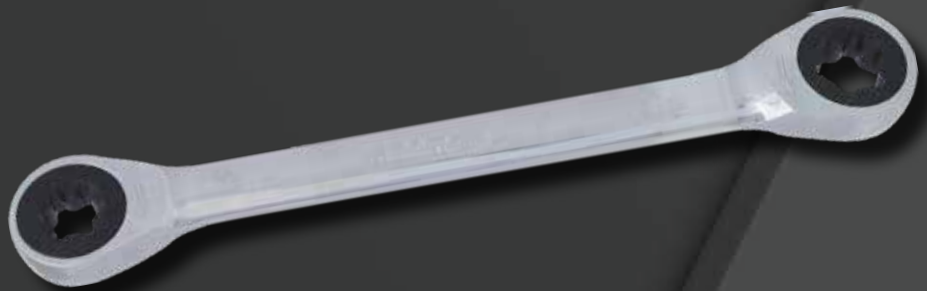

		A1 mm	A2 mm	B1 mm	B2 mm	L mm	
<b>503.4351</b>	E6 x E8	6,5	6,9	16,8	20,2	128,0	€ 18, <sup>50</sup>
<b>503.4353</b>	E10 x E12	7,3	7,7	20,2	21,8	150,0	€ 18, <sup>50</sup>
<b>503.4355</b>	E14 x E18	9,0	9,9	26,5	29,5	190,0	€ 21, <sup>50</sup>
<b>503.4357</b>	E20 x E24	10,3	11,2	31,5	33,5	230,0	€ 24, <sup>90</sup>

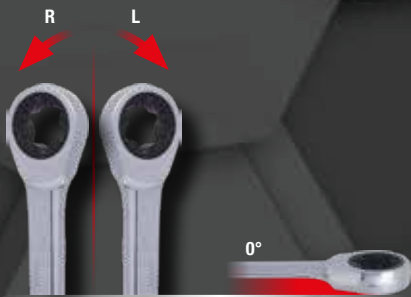

## 503.4364

### GEARplus® DOUBLE RING RATCHETING SPANNER SET FOR TORX E PROFILE

- Ideally suited for the assembly and disassembly in tight-fitting areas and changing the transmission
- Torx E
- Straight form
- Exact gearing with 72 teeth
- Mirror polished
- Chrome vanadium

4  
pcs

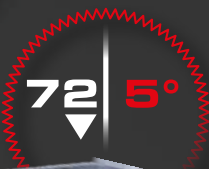

E6xE8 - E10xE12 - E14xE18 - E20xE24

**79,<sup>50</sup>** €

# DOUBLE RING SPANNERS

**503.4645**

**GEARplus® UNIVERSAL DOUBLE RATCHET RING SPANNER SET**

- Ratchet head 15° offset
- Exact gearing with 72 teeth
- With reversing lever
- With through inserts
- Waistband to key insert prevents slipping
- Suitable for narrow spaces
- High quality finish
- Chrome vanadium
- In durable plastic storage case

**10**  
pcs

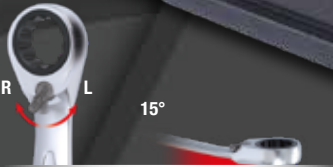
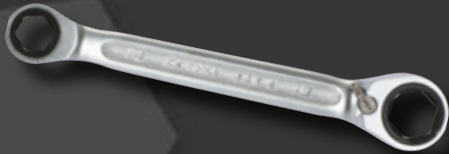

14 x 19 mm  
 8 - 9 - 10 - 11 - 12 - 13 - 15 - 16 - 17 mm

**66,50** €

**503.4625**

**GEARplus® UNIVERSAL DOUBLE RATCHET RING SPANNER SET**

- Ratchet head 15° offset
- Exact gearing with 72 teeth
- With reversing lever
- With through inserts
- Waistband to key insert prevents slipping
- Suitable for narrow spaces
- High quality finish
- Chrome vanadium
- In durable plastic storage case

**8**  
pcs

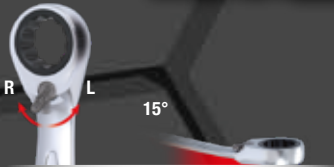
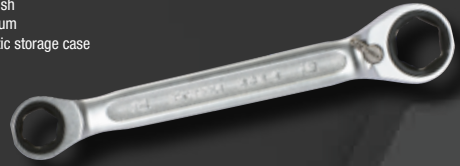

14 x 19 mm  
 5/16" - 3/8" - 7/16" - 1/2" - 9/16" - 5/8" - 11/16"

**Inches**

**57,90** €

8 - 17 mm

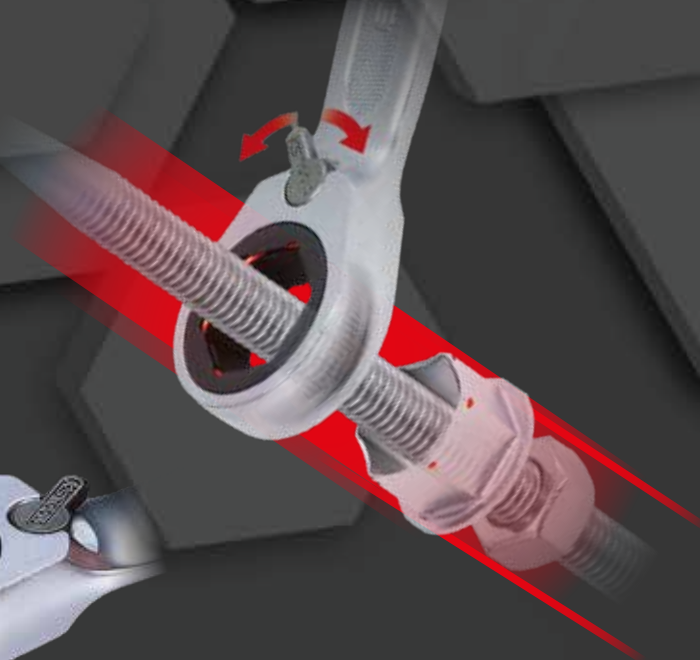



## GEARplus® BIT ADAPTER

- FlankTraction profile (12 point)
- Mirror polished
- Chrome vanadium



1/4" 5/16" 10 mm

	mm	Ø	L mm	B mm	
503.4290	10,0	1/4"	15,7	11,0	€ 4, <sup>50</sup>
503.4292	13,0	5/16"	15,3	15,5	€ 6, <sup>50</sup>
503.4293	13,0	10 mm	21,0	21,0	€ 6, <sup>50</sup>

## 503.4294

### GEARplus® BIT ADAPTER SET

- FlankTraction profile (12 point)
- Mirror polished
- Chrome vanadium

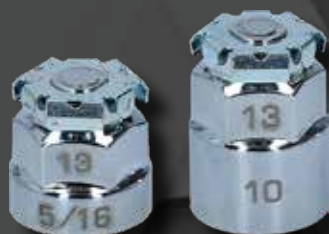

5/16" 10 mm

2 pcs

16,<sup>50</sup> €

13 mm x 5/16" - 13 mm x 10 mm

## 503.4998

### GEARplus® SOCKET ADAPTER FOR RING STOP SPANNER

- With a push button quick release function
- Suitable for ring stop spanners
- Square drive adaptor to DIN 3120 / ISO 1174 with ball lock
- Mirror polished
- Chrome vanadium

1/2"

7,<sup>50</sup> €



mm	Ø	B mm	L mm
19 mm	1/2"	21,4	28,8

## GEARplus® SOCKET ADAPTER

- With a push button quick release function
- FlankTraction profile (12 point)
- Square drive adaptor to DIN 3120 / ISO 1174 with ball lock
- Mirror polished
- Chrome vanadium



1/4" 3/8" 1/2"

	mm	Ø	L mm	B mm	
503.4296	10 mm	1/4"	16,7	11,1	€ 6, <sup>50</sup>
503.4297	13 mm	3/8"	21,7	14,5	€ 6, <sup>50</sup>
503.4298	19 mm	1/2"	28,8	21,4	€ 7, <sup>50</sup>

## 503.4286

### GEARplus® SOCKET ADAPTER SET, FOR METRIC SPANNER

- With a push button quick release function
- Suitable for metric GEARplus® spanners
- Square drive adaptor to DIN 3120 / ISO 1174 with ball lock
- For bits to DIN 3126 / C 6,3
- Mirror polished
- Chrome vanadium



1/4" 3/8" 1/2" 10 mm

4 pcs

21,<sup>50</sup> €

10 mm x 1/4"  
10 mm x 1/4" - 13 mm x 3/8" - 19 mm x 1/2"

## 503.4287

### GEARplus® SOCKET ADAPTER SET, FOR IMPERIAL SPANNERS

- With a push button quick release function
- Suitable for imperial GEARplus® spanners
- Square drive adaptor to DIN 3120 / ISO 1174 with ball lock
- For bits to DIN 3126 / C 6,3
- Mirror polished
- Chrome vanadium



1/4" 3/8" 1/2" 3/4"

4 pcs

21,<sup>50</sup> €

3/8" x 1/4"  
1/4" x 3/8" - 3/8" x 1/2" - 1/2" - 3/4"

# RATCHET WRENCH



The GEARplus® ring ratcheting spanner offer all the benefits of a ratchet and much more...  
 The ultra slimline design of the ring sides allows work in very narrow places, even where normal ratchets and sockets can't be used.  
 Allows very quick loosening or tightening of difficult nuts and bolts.



Further development of the progressive gearing means an increase in the transmission of up to 30% more torque compared to previous ring ratcheting spanners.  
 The components of the ratchet mechanism are manufactured from special high grade steel.  
 Thereby the GEARplus® reaches and even surpasses the DIN and ANSI torque standards for standard combination spanners.



The especially robust ratchet mechanism with 72 teeth works with a ratcheting angle of only 5° which makes it possible to work in confined spaces.  
 Standard combination wrenches require a ratcheting angle of at least 30° which means continual re-mounting of the wrench.  
 This awkward process now belongs to the past.



All GEARplus® ratchet ring spanners are of course fitted with the proven FlankTraction system to optimise the torque transmission.  
 This enables 100% power transfer to the faces of the nuts or bolts being worked on.  
 A further multitude of applications are offered by the valued bit and socket adaptors which can be obtained as separate accessories.



Your Local Distributor

